

# DRY TYPE TRANSFORMER SPECIFICATION

## TRANSFORMER SPECIFICATION

RATING	750kVA
COOLING	ANN
TEMPERATURE RISE	115°C
PHASES	3
FREQUENCY	60Hz
K-FACTOR	4

	PRIMARY	SECONDARY
VOLTAGE	208V	208Y/120V
TAPS - FCAN	1 x 5.0%	-
TAPS - FCBN	1 x 5.0%	-
BIL	10kV	10kV

CONDUCTOR	COPPER
WINDINGS	POLYESTER RESIN DIPPED
INSULATION CLASS	220°C
IMPEDANCE (@ 135°C)	4.0% - 6.0%
MIN EFFICIENCY	99.23% @ 35% LOAD, 75°C
AVG. SOUND LEVEL	64dBA
ELECTROSTATIC SHIELD	ELECTROSTATIC SHIELD INSTALLED BETWEEN PRI & SEC
EST. WEIGHT	5455 lbs [2480kg]

## TERMINALS AND CABLE LUGS

	PRIMARY	SECONDARY
LOCATION	FRONT	REAR
LINE LUGS (/PH)	PADS	PADS
NEUTRAL LUGS	N/A	PADS
GROUND LUG	600 MCM-2 AWG LUG ON ENCLOSURE BASE	

## WIRING / CONNECTIONS

PRIMARY: H1-H2-H3		
VOLTAGE	% TAP	LINKS:
218	105.0%	1-2
208	100.0%	2-3
198	95.0%	3-4

  

SECONDARY: X0-X1-X2-X3		
VOLTAGE	PHASE	CONNECT LOAD TO
208	3	X1-X2-X3
120	1	X0-X1, X0-X2, AND/OR X0-X3

## FEATURES

- NEOPRENE ANTI-VIBRATION PADS INSTALLED BETWEEN CORE & COIL AND ENCLOSURE BASE
- LUG FOR EARTH GROUNDING PROVIDED
- SUITABLE FOR NON-SINUSOIDAL CURRENT LOAD WITH K-FACTOR NOT TO EXCEED 4
- NEUTRAL SIZED FOR 200% OF LINE CURRENT
- SEISMIC RATED FOR USA ZONE 4 AND CANADA ZONE 6
- CSA CERTIFIED (FILE # LR34493)
- UL LISTED (FILE # E108255)
- ISO 9001 QUALITY MANAGEMENT SYSTEM
- EFFICIENCY MEETS OR EXCEEDS:
  - CANADA: SOR/DORS/2018-201 (NRCAN 2019)
  - CSA: CSA C802.2-18
  - USA: DOE 10 CFR PART 431:2016-01 (DOE 2016)

- 1) Location of nameplate and labels for Canada
  - 2) Location of nameplate and labels for USA
- \*Recommended area for side cable entry (7'x55") on either side

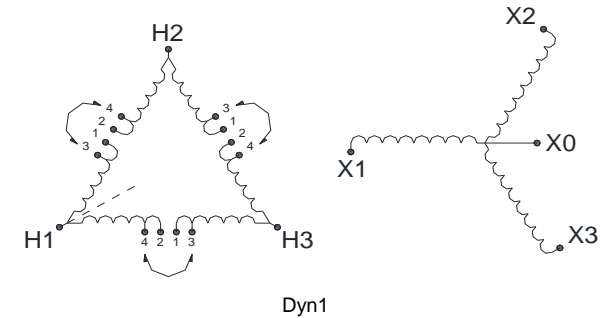
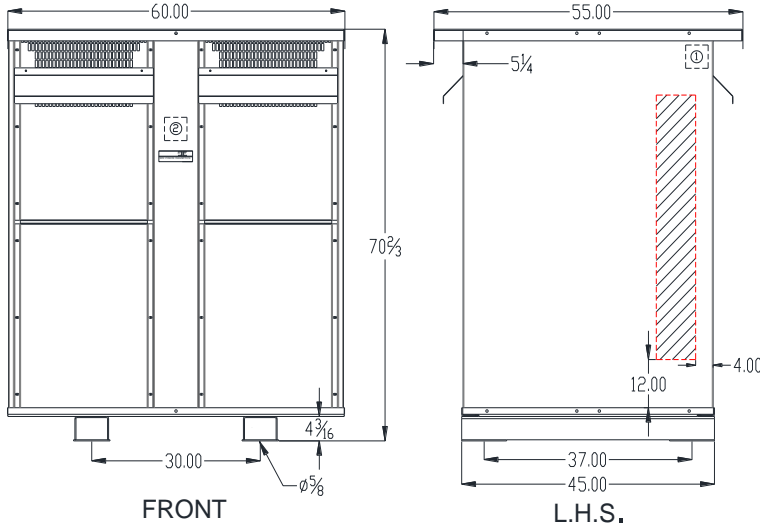

## ENCLOSURE

ENCLOSURE PART #	E3R-11
ENCLOSURE RATING	TYPE 3R (INDOOR)*
CONSTRUCTION	VENTILATED
MATERIAL	STEEL
FINISH	POLYESTER POWDER COAT
COLOR	ANSI/ASA 61 (GREY)
MOUNTING	FLOOR

\*SPRINKLERPROOF WHEN THE ANGLE BETWEEN SPRINKLER HEADS AND OPENING IN THE ENCLOSURE DOES NOT EXCEED 45 DEGREE FROM THE VERTICAL.

\*FOR PROPER VENTILATION FOR FLOOR INSTALLATION KEEP AT LEAST 6 INCHES FROM ADJACENT WALLS

REV	REMARKS	BY	DATE	PRELIMINARY DRAWING	PRODUCT	K-FACTOR RATED ISOLATION TRANSFORMER
				THIS DRAWING MAY NOT TRULY REFLECT OUR FINAL DESIGN. ANY ORDER(S) MUST BE ACCOMPANIED BY OR REFER TO THIS DRAWING. REX POWER MAGNETICS RESERVES THE RIGHT TO CHANGE OR REVISE THESE SPECIFICATIONS WITHOUT NOTICE	MODEL / CAT No.	BC750B-M/K4/S1/T115/Z3
					CUSTOMER	-
					PO #	-
					SWO #	- QTY -
					Prepared By	C.G. Date 8/18/2020
					Approved By	Date -

